



SAP *PI*

tutorialspoint

S I M P L Y E A S Y L E A R N I N G

www.tutorialspoint.com

<https://www.facebook.com/tutorialspointindia>



<https://twitter.com/tutorialspoint>

About the Tutorial

SAP Process Integration is a part of the SAP NetWeaver platform. It is called SAP NetWeaver Exchange Infrastructure XI in NetWeaver 7.0 ehp2 and older versions. SAP NetWeaver Process Integration is a part of the NetWeaver software component and is used for exchange of information in company's internal system or with external parties.

This tutorial will walk you through the different features of SAP PI.

Audience

This tutorial is designed for all those readers who are willing to learn integration work with SAP Process Integration in simple and easy steps. Readers who wish to refresh their PI knowledge can also draw benefits from this tutorial.

Prerequisites

The course is designed for beginners with little or no knowledge of SAP PI. But you need to have a preliminary understanding of SAP Basics to make the most of this tutorial.

Disclaimer & Copyright

© Copyright 2018 by Tutorials Point (I) Pvt. Ltd.

All the content and graphics published in this e-book are the property of Tutorials Point (I) Pvt. Ltd. The user of this e-book is prohibited to reuse, retain, copy, distribute or republish any contents or a part of contents of this e-book in any manner without written consent of the publisher.

We strive to update the contents of our website and tutorials as timely and as precisely as possible, however, the contents may contain inaccuracies or errors. Tutorials Point (I) Pvt. Ltd. provides no guarantee regarding the accuracy, timeliness or completeness of our website or its contents including this tutorial. If you discover any errors on our website or in this tutorial, please notify us at contact@tutorialspoint.com.

Table of Contents

About the Tutorial	i
Audience	i
Prerequisites	i
Disclaimer & Copyright	i
Table of Contents	ii
1. SAP PI – INTRODUCTION.....	1
Why do We Need SAP PI?	2
2. SAP PI — INSTALLATION OPTIONS.....	4
3. SAP PI — NETWEAVER PI ARCHITECTURE.....	5
4. SAP PI — UI TOOLS.....	8
SAP GUI	8
SAP PI — Platform	9
5. SAP PI — HOME PAGE	10
Enterprise Services Repository (ESR)	10
Integration Directory	14
6. SAP PI — SYSTEM LANDSCAPE DIRECTORY.....	16
Configuration and Monitoring	17
Monitoring Tab.....	18
Configuration and Administration Tab.....	18
Testing Tab	19

7. SAP PI – COMMUNICATION	21
Synchronous Communication	21
Asynchronous Communication	22
SAP PI – Technologies	24
8. SAP PI – SECURING OBJECTS	25
9. SAP PI – CREATING OBJECTS	27
10. SAP PI – MODELING SCENARIOS	30
11. SAP PI – DESIGN OBJECTS	32
12. SAP PI – DISPLAY DESIGN OBJECTS	33
13. SAP PI – INTEGRATION SCENARIOS	37
How to Transfer Software Components in SLD?	37
14. SAP PI – FILE TO FILE SCENARIO	39
SAP PI – File to File Scenario Execution	39
Creating a Message Type	44
15. SAP PI – CREATING SERVICE INTERFACE	47
16. SAP PI – CREATING MESSAGE MAPPING	50
17. SAP PI – CREATING OPERATION MAPPING	54
18. SAP PI – CREATING A COMMUNICATION CHANNEL	58
19. SAP PI – CREATING INTEGRATED CONFIGURATION	62
20. SAP PI – CONNECTIVITY	69
Available Adapters in SAP NetWeaver PI.....	69

How to Check Existing Adapter Engines?	70
21. SAP PI — CCBPM OVERVIEW	73
22. SAP PI — CCBPM CONFIGURATION	74
SAP PI — Integration Processes	74
23. SAP PI — MONITORING INTEGRATION PROCESSES	76
24. SAP PI — WEB SERVICES	79
Web Service – Key Features	80
How to Analyze Different Web Services?	80
Where SAP PI is Not Recommended?	81

1. SAP PI – Introduction

SAP Process Integration is a part of the SAP NetWeaver platform. It is called SAP NetWeaver Exchange Infrastructure XI in NetWeaver 7.0 ehp2 and older versions. SAP NetWeaver Process Integration is a part of the NetWeaver software component and is used for exchange of information in company's internal system or with external parties.

SAP PI/XI enables you to set up cross system communication and integration and allows you to connect SAP and non-SAP systems based on different programming language like Java and SAP ABAP. It provides an open source environment that is necessary in complex system landscape for the integration of systems and for communication.

SAP Process Integration is a middleware to allow seamless integration between SAP and non-SAP application in a company or with systems outside the company.

Example

An application that is run on different systems that are part of different business units in a company or implemented in a distributed environment between different companies that have a business relationship with each other. In this environment, there is a need for seamless integration and transfer of information between different systems. SAP PI provides a middleware platform that doesn't deal with how application components are implemented with a business logic and focuses more on data exchange between the different components.

You can consider SAP PI as a central instance or middleware that interconnects different systems. This middleware can be referred as SAP PI runtime engine and this communication is called mediated communication. When you compare this communication with a point to point scenario, it is easy to manage the systems and connections. In addition to all this, information related to integration is available at one central point.

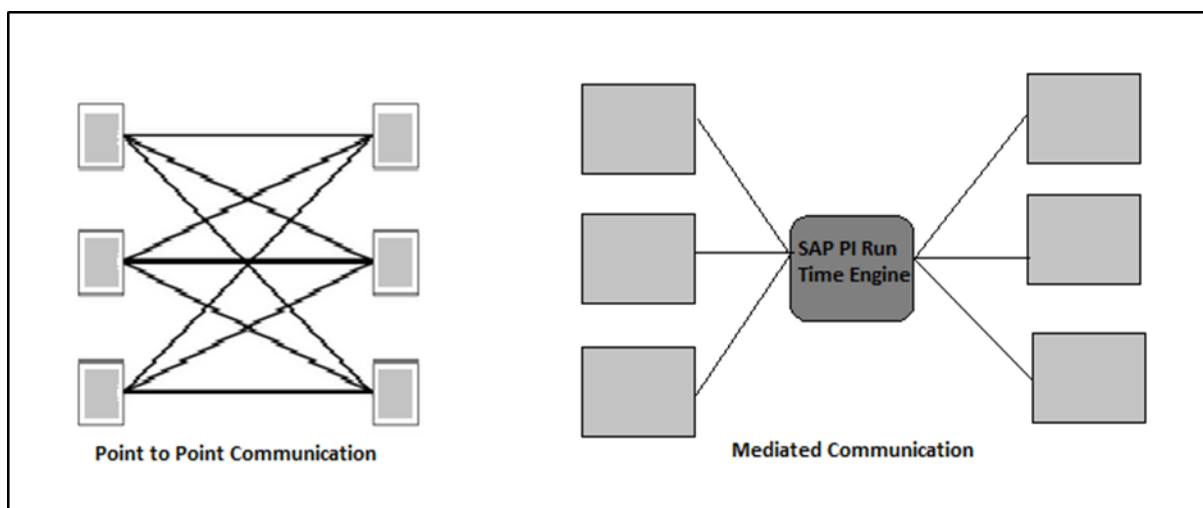

The message exchange between the different systems using SAP PI contains business data. The communication message protocol is based on W3C standard SOAP messages.

Why do We Need SAP PI?

In an organization, SAP ERP doesn't contain a single system but consists of a number of integrated systems like SAP CRM, FICO, EWM, etc. SAP PI provides a platform as single point of integration for all systems without touching complex legacy system for all data and information exchange.

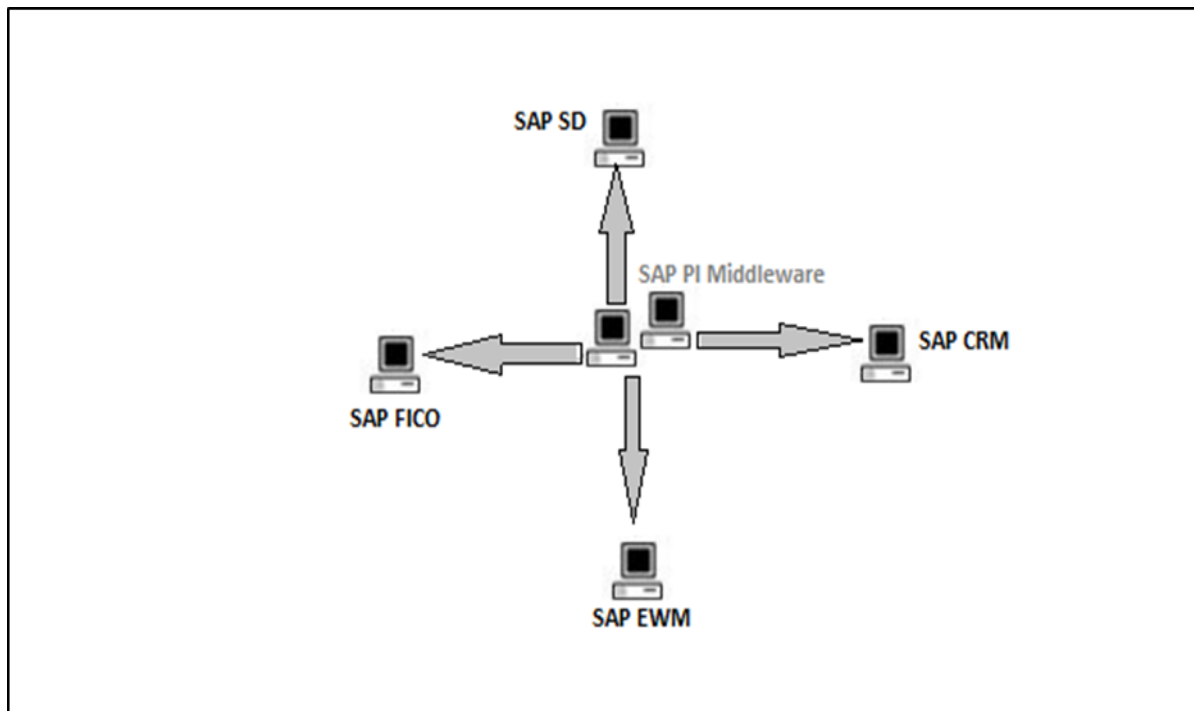

The following are the key capabilities provided by SAP Process Integration:

Connectivity

Using SAP PI, you can connect different applications and systems that have different technical ways of communication. SAP PI provides you with a variety of adapters that allow you to connect applications based on different protocols like HTTPS or Remote Function Call (RFC).

Routing

Routing defines the rules for flow of messages between different systems at runtime.

Mapping

SAP PI is used to connect different applications or systems in a distributed environment that can be set up between different companies, so there is a possibility that the structure of data exchange between two components differs from each other.

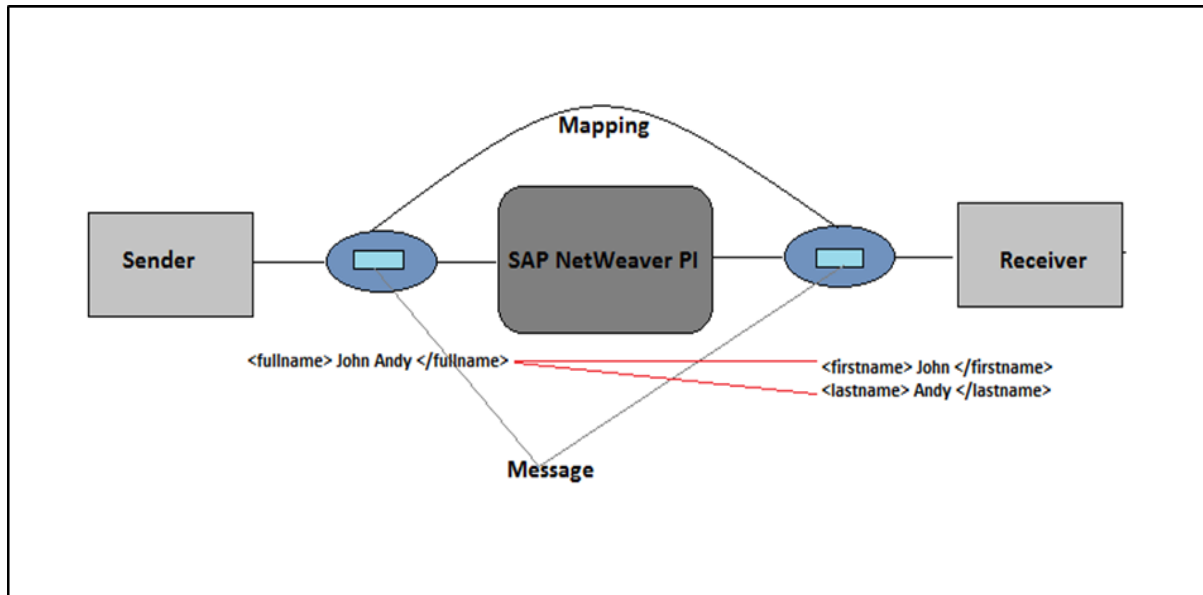

Mapping determines the structure of data in a source system to structure of data in a target system. It also determines the conversion rules that are applied to the data between source and target system.

2. SAP PI — Installation Options

When you run a scenario in SAP PI, the communication and processing capabilities depend on runtime engines that are installed with the installation of SAP PI. You can install one or more runtime engines on a host system. SAP PI provides the following two installation options:

Type 1 — Dual Usage Type

This installation is based on ABAP and Java and provides tools for designing and configuring integration content and also these runtime engines:

- Integration Engine
- Business Process Engine
- Advanced Adapter Engine

Type 2 — Advance Adapter Engine Extended AEX

This installation is based on Java and provides tools for designing and configuring integration content and contains Advance adapter engine as runtime engine.

3. SAP PI — NetWeaver PI Architecture

SAP PI architecture consists of multiple components which are used at design time, configuration time and runtime. In SAP PI, the sender system is known as the source and the receiver is called the target system and the architecture is known as **Hub and Spoke structure**. The Spoke is used to connect with external systems and Hub is used to exchange messages.

A SAP PI system is divided into the following components:

- Integration Server
- Integration Builder
- System Landscape Directory SLD
- Configuration and Monitoring

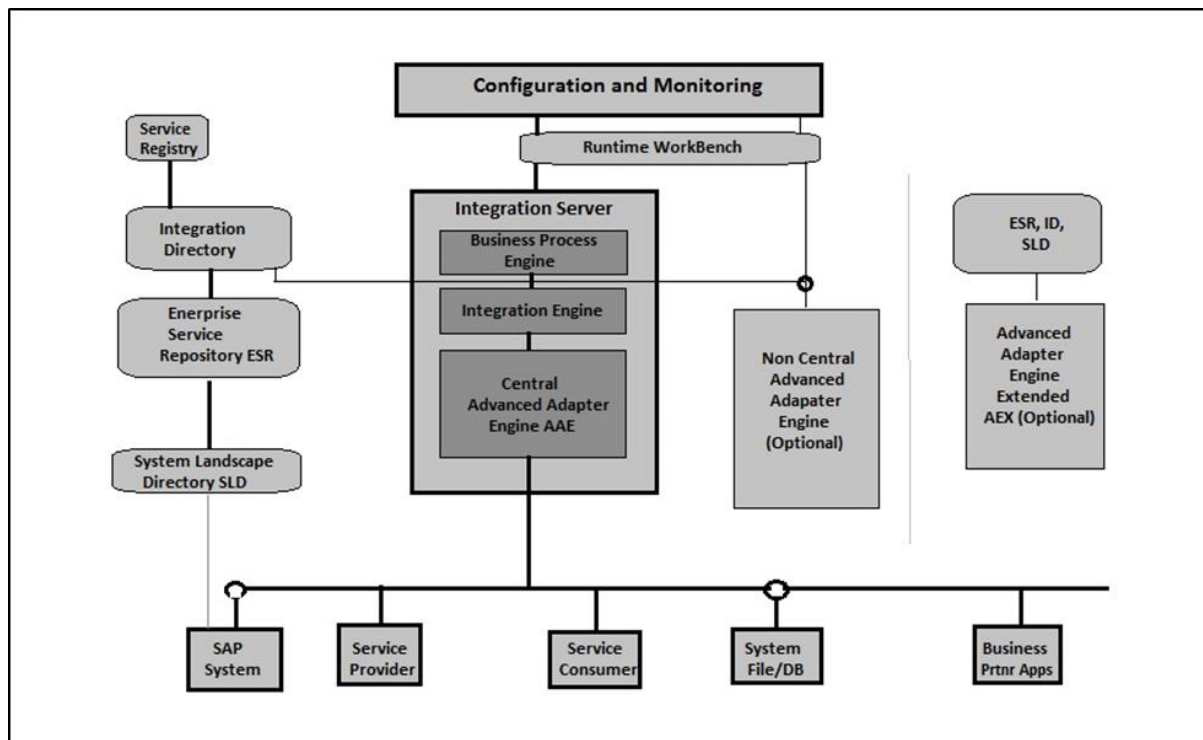

Runtime Workbench

This is a tool used to provide central monitoring of PI components and messages.

Integration Server

This is one of the key components of the SAP PI system and is used for processing of messages.

It consists of the following three engines:

- Business Process Engine
- Integration Engine
- Central Advanced Adapter Engine AAE

Business Process Engine

This engine is used for message correlation and deals with the processing of messages in ccBPM.

Integration Engine

This engine is used for routing and mapping and provides central integration server services. If the source structure is different from the target structure, the integration engine calls mapping runtime as shown in the illustration below wherein, the source structure is converted to target structure.

A mapping runtime is based on Java Stack as mentioned under the SAP PI platform topic.

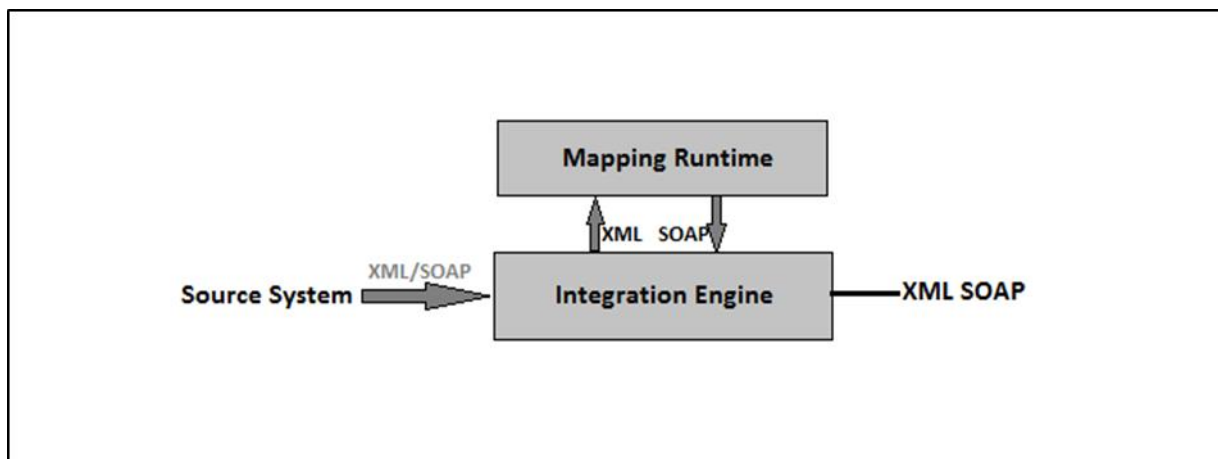

A message can be of the following two types:

- **Synchronous message** is defined as message contains both the request-response part
- **Asynchronous message** is defined as message contains either request or the response part only

In SAP PI, a message is represented by an interface. An Interface contains the structure of the message in XML format and the direction.

Central Advanced Adapter Engine (AAE)

As Integration Engine handles messages in XML and SOAP protocol, if the business system doesn't contain data in a specific format, adapters are used to convert the messages specific protocol and message format required by the Integration Engine.

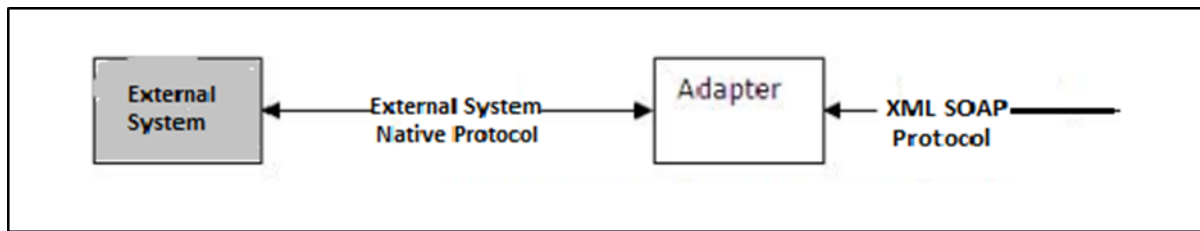

In SAP PI architecture, you can consider Adapter Engine as Spoke and Integration Engine as HUB to connect to external systems.

In SAP PI older releases dual stack system, most of the adapters were part of Java stack and only two adapters were part of ABAP stack.

Java Stack Adapters

The following adapters run on Java Stack:

RFC adapter, SAP Business Connector adapter, file/FTP adapter, JDBC adapter, JMS adapter, SOAP adapter, Marketplace Adapter, Mail adapter, RNIF adapter, CIDX adapter

ABAP Stack Adapters

The following adapters run on ABAP Stack:

IDOC and HTTP Adapter	In the latest releases when SAP PI moved to the single stack system, these two adapters also moved to the Java stack and the new engine thus formed is known as Advanced Adapter Engine AAE.
Service Repository	Services Registry is a UDDI compliant registry, listing available Web Service Definitions (based on WSDL), extended with a classification system.
Enterprise Service Repository	This is used to store design time repository objects like mapping, interfaces and process definitions in the PI system.
System Landscape Directory (SLD)	This contains the information about landscape and software component versions. A SAP system can be configured to register under SLD.
Integration Repository	This is used to configure the scenarios in PI system for exchange of messages between different systems.

4. SAP PI – UI Tools

You can use different SAP PI user interface tools to access different components of SAP PI system architecture. The most common UI tools are:

- **ES Builder** - This tool provides Java user interface for working in Enterprise Service Repository ESR.
- **SAP NW Developer Studio** - This is Java Eclipse-based tool to view and edit some object types in Enterprise Service Repository.
- **Integration Builder** - This tool provides Java-based user interface to work in the Integration Directory.

SAP GUI

This is SAP client tool to access ABAP stack of the SAP PI system.

The following illustration shows the different UI tools of SAP PI and the components that can be accessed using these tools:

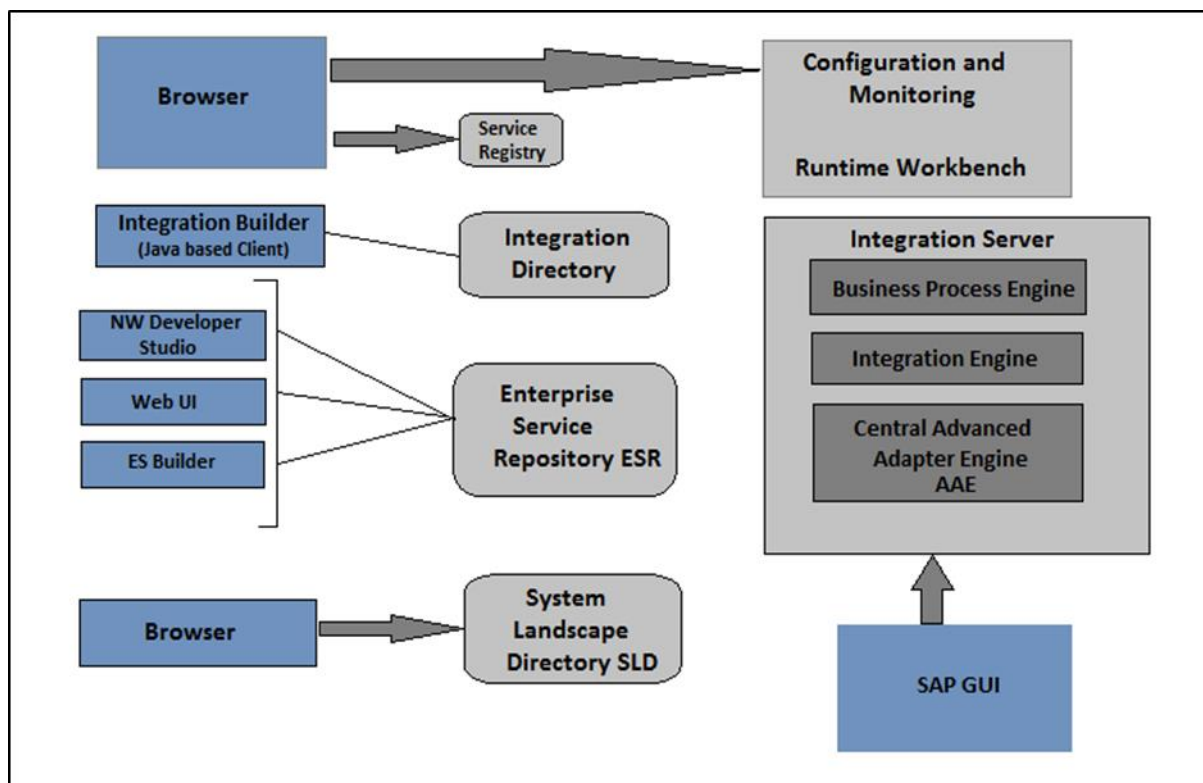

SAP PI — Platform

Single Stack Vs Dual Stack

In SAP PI older releases, not all the components were based on a single platform. Few components like Integration Engine, Business Process Engine and Integration Builder were based on ABAP stack and other components like Enterprise Service Repository ESR, Integration Directory (SLD, Adapter Engine, etc.) were based on Java Stack. So these type of systems were called dual stack systems as PI required both ABAP and Java stack to run.

ABAP Stack	Java Stack
Integration Engine	Enterprise Service Repository ESR
Business Process Engine	Integration Directory
Integration Builder	(Runtime Workbench, System Landscape, Adapter Engine, Mapping Runtime)

In the latest releases of SAP PI, ABAP stack components are modified to work on Java stack so, SAP PI needs only Java stack to run and is called the single stack system.

5. SAP PI — Home Page

To open SAP PI Tools home page, use the following URL:

`http://<host>:5<instance#>00/dir/start/index.jsp`

Example — `http://scmehp2:50200/dir/start/index.jsp`

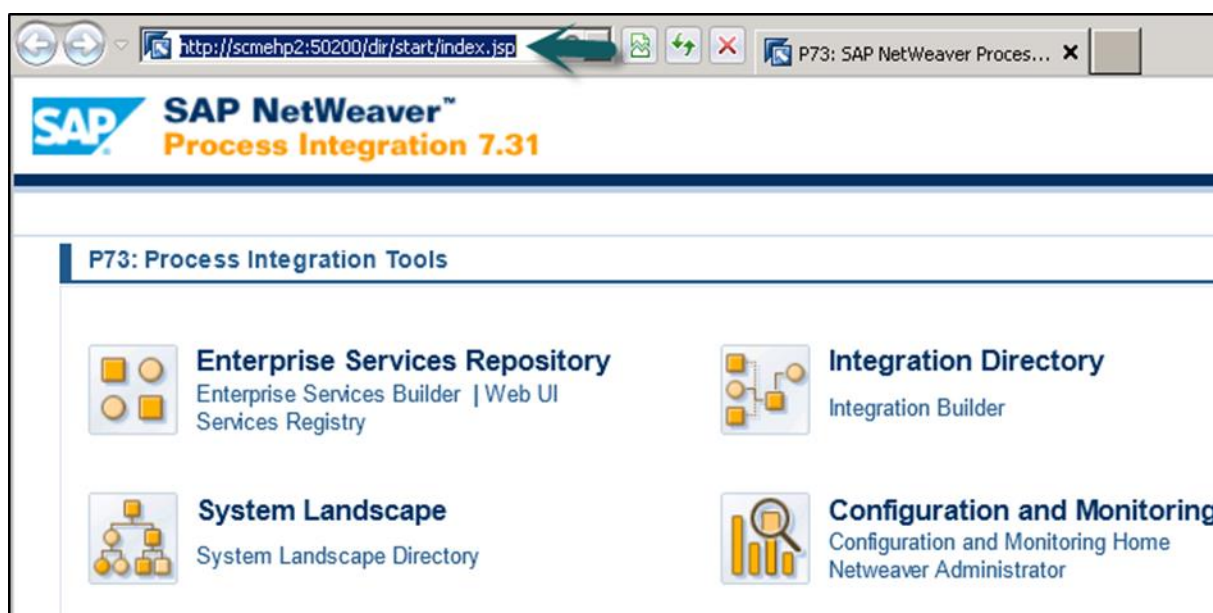

SAP PI home page has the following four Java links:

- Enterprise Services Repository (ESR)
- Integration Directory (ID)
- System Landscape (SL)
- Configuration and Monitoring (CM)

Enterprise Services Repository (ESR)

In SAP PI, Enterprise Service Repository is used to design and create objects to be used in the integration scenario. You can design Interface Objects, Mapping Objects and the different integration processes.

Interface Objects

The following are the Interface Objects:

- Service Interface
- Data type
- Message type

Mapping Objects

Mapping of messages is done as per the sender and the receiver data structure

Integration Processes

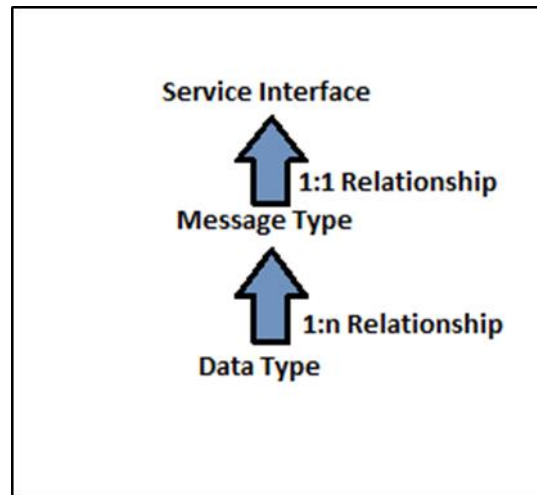

Operation Mapping is used for converting the source structure to target structure if data structure is different. Complex Operation Mapping can be simplified using Message Mapping.

Message Mapping can be implemented in the following ways:

- Graphical Mapping
- Java Mapping
- XSLT Mapping
- ABAP Mapping

Under Enterprise Service Repository, you can see different UI tools — Enterprise Service Builder and Web UI and Service Registry.

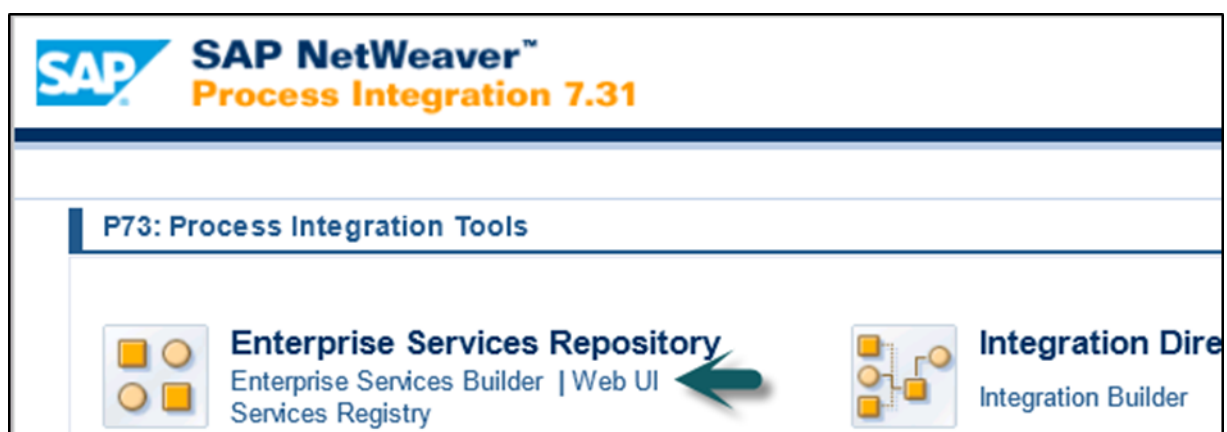

When you launch the Enterprise Service ES Builder application, you get an option to run the application for the first time as shown in the following screenshot. Click Run.



Once the application is launched, you get the following options:

- Main Menu Bar and Standard Toolbar at the top
- Navigation Area on the left side
- Work Area on the right side

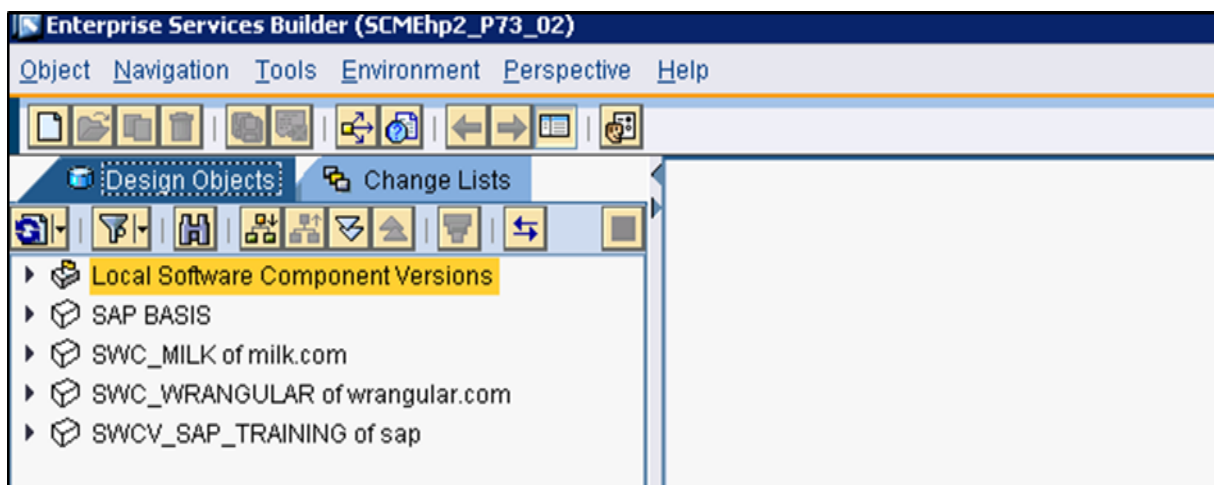

The object editors are displayed in the work area. These object editors include functions that relate specifically to the objects that are open.

When you run Web UI, you will be prompted to enter the username and password.

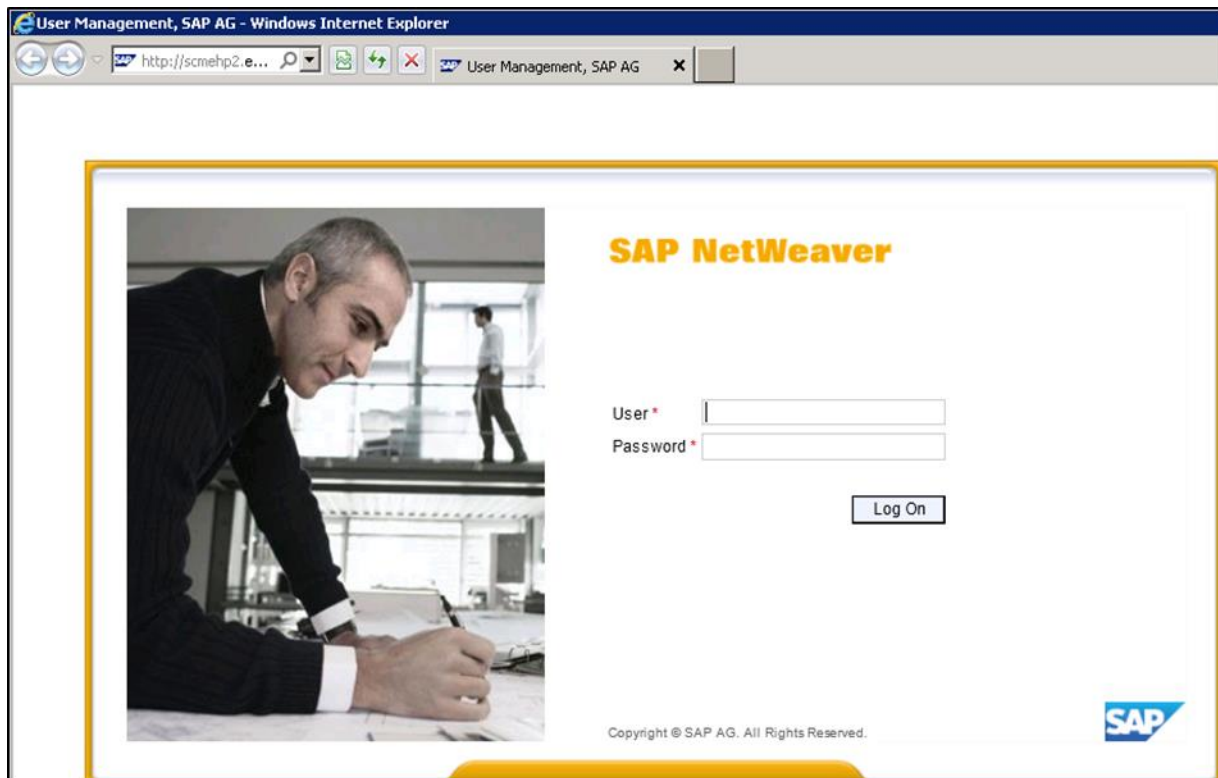

In Web-based interface, you can perform the following tasks:

- **Search** - Search for service interfaces, data types, and so on.
- **Subscribe** - Subscribe for Notifications.
- **Manage** - Manage lifecycle status of service interfaces, data types, and so on.

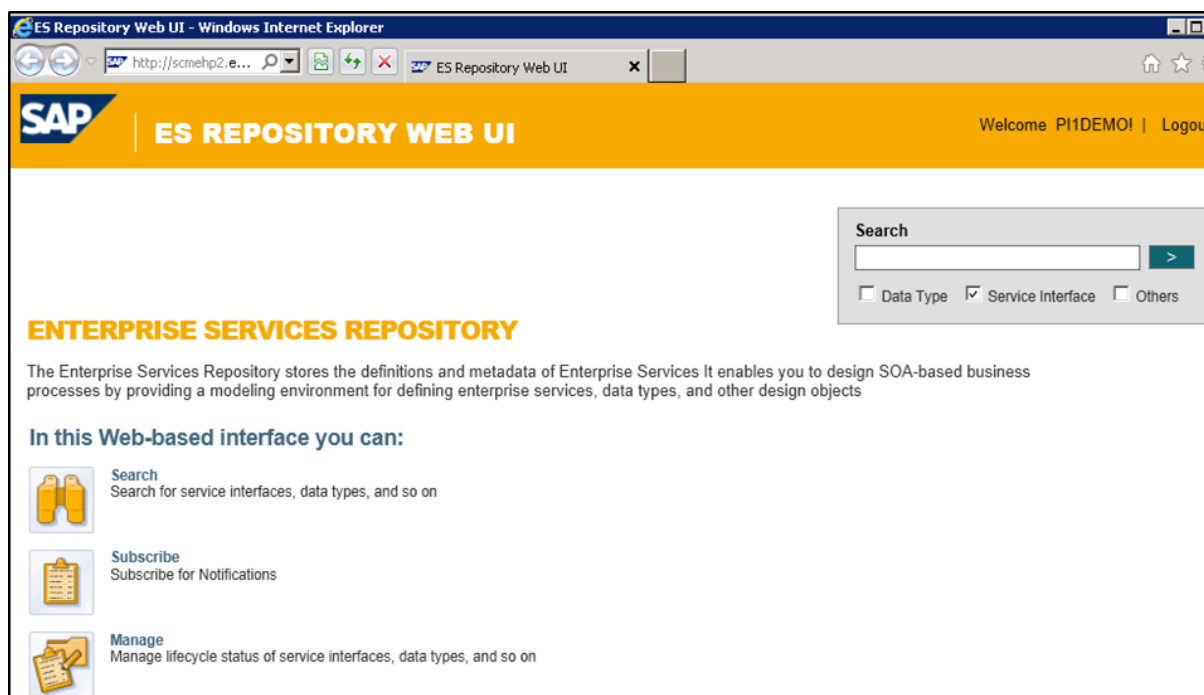

Integration Directory

Integration Directory is used for the configuration of objects that are created in Enterprise Service Repository and configuration is executed by the Integration Engine at runtime. To configure ESR objects, you need to import object — Service and Communication Channel.



Service allows you to address the sender or the receiver of messages. Depending on how you want to use the service, you can select from the following service types:

- Business System
- Business Service
- Integration Process Service

Communication channel determines inbound and outbound processing of messages by converting external native messages to SOAP XML format using Adapter Engine. Two types of communication Channel — Sender Channel and Receiver Channel.

In Integration directory, you can make four types of configuration:

- **Sender Agreement** — This determines how the message is transformed by Integration server.
- **Receiver Determination** — This is used to determine information of receiver to whom message to be sent.

- **Interface Determination** — This is used to determine the inbound interface to which the message is to be sent. This also determines the interface mapping for processing the message.
- **Receiver agreement** — This defines how a message is to be transformed and processed by the receiver.

Under Integration Directory, you can see the Integration Builder. When you click the Integration Builder, you can see the different options to configure the objects created in ESR.

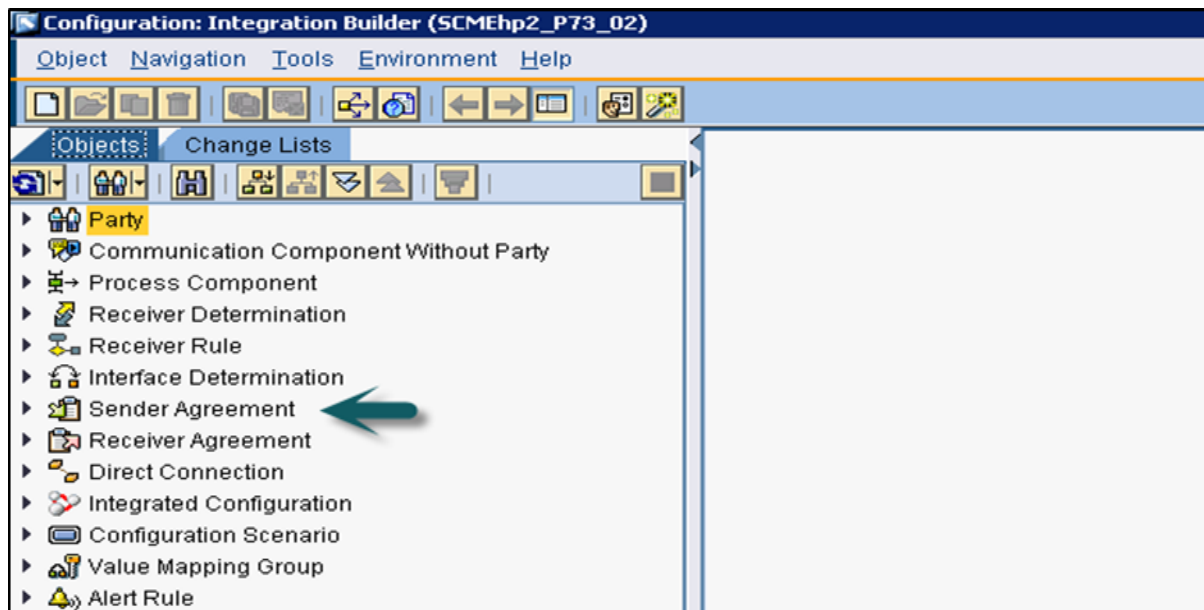

End of ebook preview

If you liked what you saw...

Buy it from our store @ <https://store.tutorialspoint.com>